

## Door side sensor

### ■ Features

- Long sensing distance : 0 to 10m
- High ambient intensity of illumination :  
Max. 100,000 lux of sunlight
- Easy to connect sensor head to controller
- Easy sensitivity setting  
(automatic sensitivity setting by open push method)
- Self-diagnosis function
- Compact Size(W77×L44×H30mm)

 Please read "Caution for your safety" in operation manual before using.

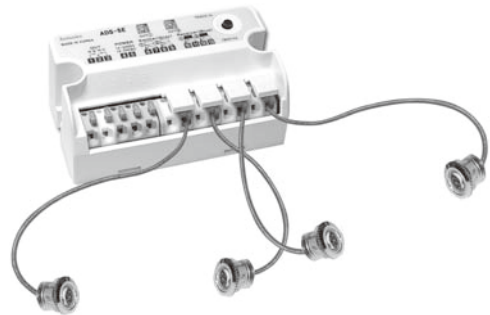

### ■ Specifications

|                              |  |  |
|------------------------------|--|--|
| Model                        | <b>ADS-SE</b>  |  |
| Sensing type                 | Through-beam type  |  |
| Sensing distance             | 0 to 10m   |  |
| Power supply                 | 12-24VAC/DC ±10%(Ripple P-P : Max. 10%)  |  |
| Power/Current consumption    | AC : Max. 2VA / DC : Max. 50mA   |  |
| Contact output <sup>※1</sup> | <ul style="list-style-type: none"> <li>• Contact capacity : 50VDC 0.3A(resistive load)</li> <li>• Contact composition : 1c</li> <li>• Relay life cycle : Mechanical- Min. 5,000,000 operations, Electrical- Min. 100,000 operations</li> </ul> |  |
| Response time                | Approx. 50ms(From light OFF)   |  |
| Output holding time          | Approx. 500ms(From light ON)   |  |
| Available sensor set         | 2set   |  |
| Indicator                    | Operation indicator : Red, Green(Refer to C-14 to 15 for the display status in operation)  |  |
| Light source                 | Infrared LED(850nm modulated)  |  |
| Environment                  | Ambient illumination   | Sunlight : Max. 100,000lx(Receiver illumination) |
|                              | Ambient temperature  | -20 to 55°C, storage : -25 to 60°C               |
|                              | Ambient humidity   | 35 to 85%RH, storage : 35 to 85%RH               |
| Protection                   | IP30(IEC standard)   |  |
| Sensor cable length          | 10m  |  |
| Material                     | Case : ABS, Sensing part : PMMA  |  |
| Accessory                    | Sensor : 1 set(ADS-SH), Fixing bolt for controller : 2 pieces  |  |
| Unit weight                  | Approx. 300g   |  |

※1: Do not use Load which is beyond the rated capacity of contact point of Relay.

It can cause bad insulation, contact fusion, bad contact, relay breakdown, and fire etc.

※Please purchase 1 set of sensor separately when mounting 2 sets of sensor.

※The mounting bracket of sensor (ADS-SB12, ADS-SB10) is sold separately.

※It is enable to purchase a controller (ADS-SEC) separately.

※The temperature or humidity mentioned in Environment indicates a non freezing or condensation environment.

# Door Side Sensor

## ■ Identification

### ● Controller (ADS-SEC)

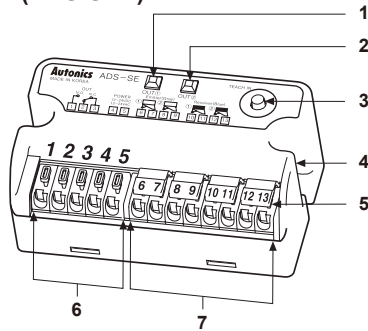

1. Display LED(Red)
2. Display LED(Green)
3. Sensitivity setting button
4. Mounting hole
5. Wiring connection button
6. Terminal for power and output(No. 1 to 5)
7. Terminal for emitter/receiver of sensor(No. 6 to 13)

### ● Sensor (ADS-SH)

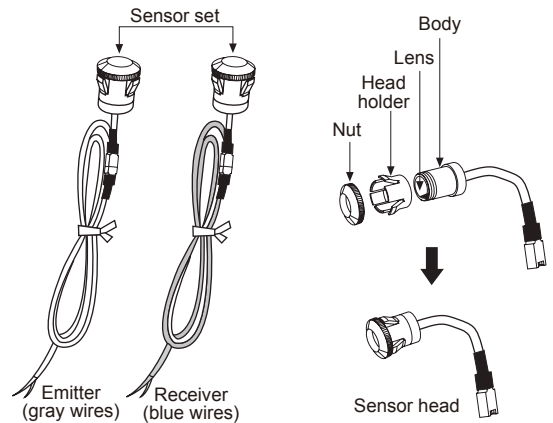

※It is able to use 2 sets of the sensor with this product.  
If it is necessary, purchase a set more for using.

## ■ Dimensions

(unit: mm)

### ● Controller (ADS-SEC)

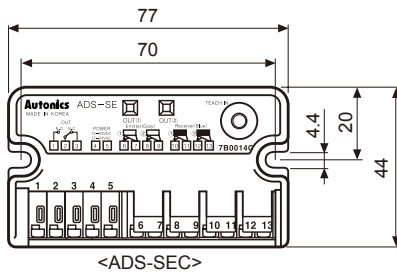

<ADS-SEC>

※It is able to purchase a controller(ADS-SEC) separately.

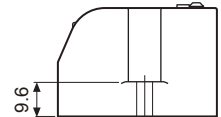
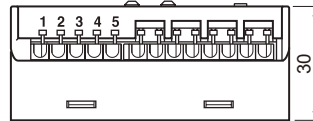

### ● Sensors (ADS-SH)

#### ● One push type

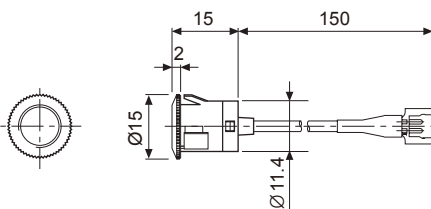

#### ● Screw type

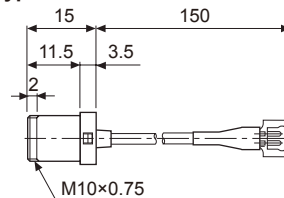

### ● Option

#### ● Sensor set

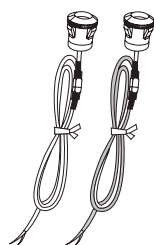

<ADS-SH>

#### ● Bracket

<For mounting by one push>

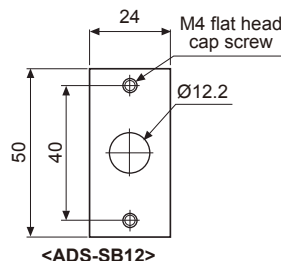

<ADS-SB12>

<For mounting by screw >

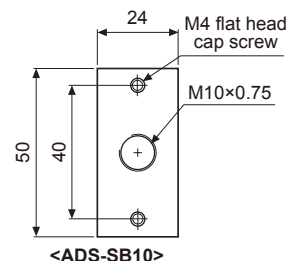

<ADS-SB10>

|     |                                  |
|-----|----------------------------------|
| (A) | Photo electric sensor            |
| (B) | Fiber optic sensor               |
| (C) | Door/Area sensor                 |
| (D) | Proximity sensor                 |
| (E) | Pressure sensor                  |
| (F) | Rotary encoder                   |
| (G) | Connector/ Socket                |
| (H) | Temp. controller                 |
| (I) | SSR/ Power controller            |
| (J) | Counter                          |
| (K) | Timer                            |
| (L) | Panel meter                      |
| (M) | Tacho/ Speed/ Pulse meter        |
| (N) | Display unit                     |
| (O) | Sensor controller                |
| (P) | Switching mode power supply      |
| (Q) | Stepper motor& Driver&Controller |
| (R) | Graphic/ Logic panel             |
| (S) | Field network device             |
| (T) | Software                         |
| (U) | Other                            |

## ■ Installation

### ◎ Caution for sensor installation

1. Sensing distance is 10m.  
Install it in the rated distance.
2. Install the sensor with more than 50cm gap from the bottom and ceiling.  
It may cause malfunction by reflected beams from the surface of the bottom and ceiling.
3. Do not put obstacles between the emitter and the receiver.  
It may cause malfunction.
4. This product is for indoor. Avoid the place where exposed in direct sunlight or is in over rated intensity of illumination.

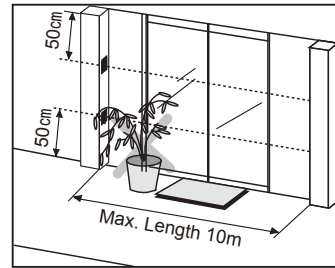

### 1. Make a hole on the side post of auto door as follows.

- **When not using the mounting bracket**
  - Mounting hole of sensor head :  $\text{Ø}12.2^{+0.1}$ mm
  - Panel thickness of sensor head :  $1.5^{+0.1}$ mm
- **When using the mounting bracket**
  - Through hole of sensor head :  $\text{Ø}13$  to  $\text{Ø}14$ mm
  - Screw hole for fixing the bracket : M4 Tap or  $\text{Ø}3.5$

### 2. Mount the sensor head in the mounting hole

- **When not using the mounting bracket**
  - One push method  
Insert the sensor head into the mounting hole like the right picture.
- **When using the mounting bracket**
  - One push method
    - 1) Install the sensor head at the bracket first.
    - 2) Fix the bracket by screws on the place for installing.

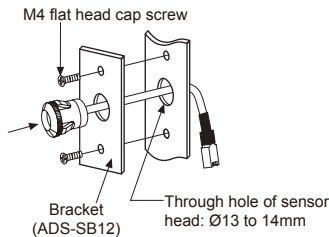

### • Screw method

- 1) Remove nuts and the head holder from the sensor head.
- 2) Install the sensor head on the bracket.
- 3) Fix the bracket on the side post of the door by screws.

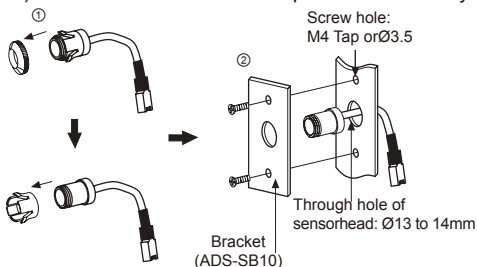

※The mounting bracket is sold separately.  
If necessary, please purchase it for using.

### ⚠ Caution For mounting hole

- Check the mounting holes for the head of the emitter and the receiver are in parallel for the optical axes.
- Grind around the mounting holes drilled smoothly.  
It may hurt a person by the sharp part and cause malfunction by sensor head inclined.

### ⚠ Caution When installing in One push method

- Check the nuts are fixed on the sensor body tightly.
- Install that there is no gap between the nuts and the side of the door(or bracket). It may cause malfunction because sensitivity setting is not available as the optical axes are not matched if sensor body is inclined.

### ⚠ Caution After installing the sensor head

- Check the damage such as scratches or pollutant on the lens of the sensor head.  
It may cause malfunction in the condition of shading light or lack of sensitivity by dust.

### ⚠ Caution For maintenance and mending

- Keep the sensor head clean.  
It may not operate normally.  
Clean it by a piece of cloth with a neutral detergent.  
Do not use organic solvent.  
It may cause damage to lens of the head by organic solvent.
- Do not wash the head part of the sensor.  
Sensor by water, it may cause product damage.

## ■ Installation

### ◎ Controller installation

- Fix controller with the bolts(M4×20, 2pcs). Process the fixing hole of controller by M4 included in the package. Refer to dimension for installation.

### ⚠ Warning When fixing controller

- Do not screw the bolts too tightly. The fixing hole of controller may be broken.

### ◎ Wiring connection

#### 1. Follow as below when adjusting wiring length.

- 1) Cut off the wiring length as much as user needs.
- 2) Connect the wire to the terminal after taking off the wire covering. It is easy to connect if soldering the end of the wires.

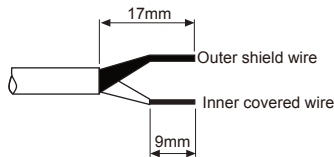

#### 2. Match wires in the number of terminals and connect them.

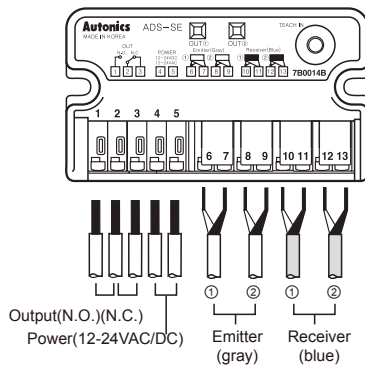

- Connection method for sensor
- Put outer shield and inner covered wires at once, pressing the insert button, then take off from the button.

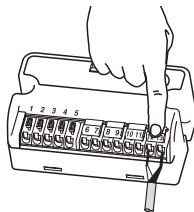

- Connection method for power and output wires
- Put the wires pressing the terminal ends by a driver etc.

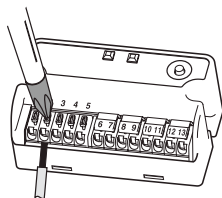

- Allowable diameter of power and output wires
  - Single wire :  $\varnothing 0.12$  to  $1.6\text{mm}^2$  (AWG26 to 16)
  - Stranded wire :  $\varnothing 0.13$  to  $1.5\text{mm}^2$  (AWG26 to 16)

### ⚠ Warning It may cause electric shock.

- Be sure of connecting wires in power off.

### ⚠ Caution It may cause damage to this product.

- Follow the left picture when cutting off the wires of sensor head. If the cover of wire is taken off too much, it may cause damage to this product as the end of both wires is shorted.

### ⚠ Caution Do not extend the wire of sensor head.

- Do not connect extended wire to the wire of sensor head. It may cause malfunction by noise.

### ⚠ Caution It may cause damage to this product.

- Do not connect two wires or more to a terminal.

### ⚠ Caution Wiring connection

- It does not operate normally if the wiring is connected conversely.

### ⚠ Caution It may cause damage to this product.

- Make sure of connecting power wire to the terminal (No. 4, 5). Otherwise, It may cause damage to this product.

(A) Photo electric sensor

(B) Fiber optic sensor

(C) Door/Area sensor

(D) Proximity sensor

(E) Pressure sensor

(F) Rotary encoder

(G) Connector/Socket

(H) Temp. controller

(I) SSR/Power controller

(J) Counter

(K) Timer

(L) Panel meter

(M) Tacho/Speed/ Pulse meter

(N) Display unit

(O) Sensor controller

(P) Switching mode power supply

(Q) Stepper motor& Driver&Controller

(R) Graphic/Logic panel

(S) Field network device

(T) Software

(U) Other

## ■ Proper usage

### ◎ Sensitivity setting

Set sensitivity after mount this product for a normal operation. It sets the optimum sensitivity automatically at the controller according to installed environment.

| Order                            | LED display                 | Status                               |
|----------------------------------|-----------------------------|--------------------------------------|
| Press sensitivity setting button | Red/Green Flashed by turns  | Ready                                |
| ↓                                | ↓                           | ↓                                    |
| After more than 1sec.            | Red/Green All LED OFF       | The beginning of sensitivity setting |
| ↓                                | ↓                           | ↓                                    |
| Take off from button             | Flashed at once             | The end of sensitivity setting       |
|                                  | ↓                           |                                      |
|                                  | Displaying operation status |                                      |

Check LED display after setting the sensitivity.

※When sensitivity setting button is pressed less than 1sec. sensitivity setting is cancelled, then it operates by previous setting.

### ⚠ Caution For mounting hole

- Check the wiring again with the connection diagram.
- When set the sensitivity, the transmitted beam must not be shaken and cut off.
- Do not put obstacles like a pot on the passage of the through beam.
- It may cause malfunction in above cases from lack of sensitivity or abnormal sensitivity setting.

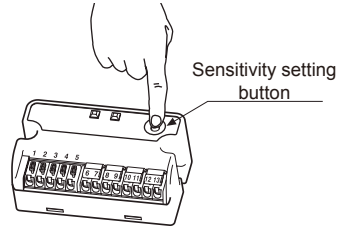

### ◎ Sensitivity status and check after setting sensitivity

☼: light ON, ◐: flash, ●: light OFF

| Connecting sensor | LED display |       | Status   |   |
|-------------------|-------------|-------|--|---|
|                   | Red         | Green |  |   |
| 1set              | ☼           | ●     | After setting sensitivity  | In operation  |
|                   | ◐           | ◐     | Sensitivity setting success  | Received light  |
|                   | ◐           | ◐     | Sensitivity setting failure  | Emitter disconnection or sensor cable extension           |
|                   | ◐           | ●     | —  | Lack of sensitivity                                       |
| 2set              | ●           | ●     | —  | Interrupted light   |
|                   | ☼           | ☼     | 1, 2-channel sensitivity setting success                                     | 1, 2-channel received light                               |
|                   | ☼           | ◐     | 1-channel sensitivity setting success, 2-channel sensitivity setting failure | 2-channel lack of sensitivity                             |
|                   | ☼           | ●     | —  | 1-channel received light, 2-channel interrupted light     |
|                   | ◐           | ☼     | 1-channel sensitivity setting failure, 2-channel sensitivity setting success | 1-channel lack of sensitivity                             |
|                   | ●           | ☼     | —  | 1-channel interrupted light, 2-channel received light     |
|                   | ◐           | ◐     | 1, 2-channel sensitivity setting failure                                     | 1, 2-channel lack of sensitivity or emitter disconnection |
| ●                 | ●           | —     | 1, 2-channel interrupted light   |   |

- After complete sensitivity setting for using one set of sensor, red LED is flashing, green LED is off and only red LED displays the operation status.

※After complete sensitivity setting in using two sets of sensors, red LED indicates the operation status of receiver set by receiver ① and green LED indicates the operation status of receiver set by receiver ②.

※Self-diagnosis function : If lack of sensitivity occurs by optical axes not matched and pollution by dust on the lens of emitter/receiver etc., the LED of normal operation channel flashes due to unstable operation.

- Check process for sensitivity setting failure

1. Check obstacles between the heads of emitter receiver.
2. Check pollutant on the lens of emitter receiver.
3. Check wires cut off and the connection with the connection diagram on the controller.
4. Check if the head of emitter/receiver is inclined or not.
5. Set sensitivity again after removing above problem.



※When sensitivity setting is failure even though above problem is solved, please contact us.

# Door Side Sensor

## ■ Operation check

Please check the operation flow chart below.

☀: light ON, ●: light OFF

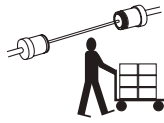
|              |           |  |  |   |
|--------------|-----------|--|--|---|
| Operation    |           |   |     |  |
| Status       | Power OFF | <ul style="list-style-type: none"> <li>• Normal operation</li> <li>• No human or any material between sensors</li> </ul> | Human or material is passing between sensors (When cutting off the transmitted beam) | After human or material is passed   |
| LED display  | ●         | ☀(red/green)   | ●  | ☀(red/green)  |
| Relay output | N.O.      | OPEN   | OPEN   | CLOSE   |
|              | N.C.      | CLOSE  | CLOSE  | OPEN  |

## ■ Troubleshooting

| Malfunction   | Cause  | Troubleshooting   |
|---|--|---|
| It does not work.   | Power voltage  | Check the power cable and adjust power voltage.                     |
|   | Cable disconnection, incorrect connection  | Please check wiring and terminal.                                   |
|   | Rated sensing distance   | Use it in rated sensing distance.                                   |
| Sometimes it does not work.                                   | Pollution by pollutant on the lens of Emitter Receiver.  | Remove the pollutant.   |
| It is operated even if people does not enter in sensing area. | Rated sensing distance   | Use it in rated sensing distance.                                   |
|   | There are obstacles between Emitter and Receiver.  | Remove obstacles.   |
|   | There is equipment generating strong noise or ratio wave(Motor, Generator, High-tension wire). | Keep away from the equipment generating strong noise or ratio wave. |

## ■ Caution for using

- When two sets of sensor are mounted closely, it may cause mutual interference by the emitter of other sensor. Therefore, please install them to avoid the interference by exchanging the head of Emitter and Receiver and by keeping the distance between the heads in more than 50cm.
- When sensor head is installed on the ceiling or floor closely, it may cause malfunction by receiving the reflected beam. Therefore, please install it by keeping the suitable height(more than approx. 50cm) from the ceiling or floor.
- When the target is a translucent or small object (Max. Ø15mm) it may not detect as the light transmits them.
- When wire sensor in the same pipe laying with the high-tension wire or power line, it may cause malfunction. Therefore, please use separated wiring or pipe laying.
- What sensor is used in much dusty or corroded place, it may cause malfunction. Please avoid these places when installing.

- When making the length of the wiring(power wire or output wire) long, it may cause malfunction by surge etc.
- When the lens of sensor head is polluted by dust etc., please clean it by dried cloth slightly. Do not use organic solvent like thinner.
- When switching mode power supply is used as the source of supplying power, please ground F.G. terminal and install a condenser for removing noise between 0V and F.G. terminal as following drawing.

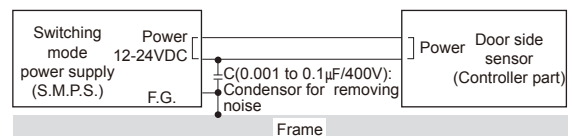

(A) Photo electric sensor

(B) Fiber optic sensor

(C) Door/Area sensor

(D) Proximity sensor

(E) Pressure sensor

(F) Rotary encoder

(G) Connector/Socket

(H) Temp. controller

(I) SSR/ Power controller

(J) Counter

(K) Timer

(L) Panel meter

(M) Tacho/ Speed/ Pulse meter

(N) Display unit

(O) Sensor controller

(P) Switching mode power supply

(Q) Stepper motor& Driver&Controller

(R) Graphic/ Logic panel

(S) Field network device

(T) Software

(U) Other